



ARP-5517AX-E01-A06

Waterproof Thin Client Panel PC with 17-inch Resistive Touch Screen Powered by 802.3bt Type 3/4 PoE

Features

- 17" LCD, 1280 x 1024 Resolution
- 5-Wire Resistive Touch
- Stainless Steel Enclosure
- Intel Celeron J1900 @ 1.99GHz / Atom E3845 @ 1.91GHz CPU
- 4GB DDR3 SO-DIMM
- 1x Gigabit Ethernet
- 2x USB 2.0 ports
- Powered By 802.3bt Type 3/4 PoE

Specifications

Model Name	ARP-5517AX-E01-A06
LCD Display	
Display Size (Diagonal)	17.0 inch
Resolution	1280 x 1024
Backlight Lifetime (Hours)	50,000 hours
Visual Characteristics	
Colors	16.7 million
Aspect Ratio	5:4
Viewing Angle (V/H)	160° / 140°
Contrast Ratio	800 : 1
Brightness	350 nits
Touchscreen	
Technology	5 Wire Resistive
Interface	USB x 2
Driver	ThinManager Supported Driver
Enclosure	
NEMA 4	N/A
NEMA 4x	Stainless Steel
System	
CPU	Intel Celeron J1900 @ 1.99GHz / Atom E3845 @ 1.91GHz CPU
Chipset	Bay Trail
Memory	4GB DDR3 SO-DIMM
Video Controller	Intel Gen7 Intel Graphics DX 11, OGL3.2
External Video Output	N/A
Storage Option	N/A
Compact Flash	N/A
Keyboard / Mouse	USB
Audio	N/A
Watchdog Timer	Programmable 1 - 255 sec
Remote Boot	ThinManager Ready, PXE
Expansion Slot	N/A
I/O Communication	
USB Port	2 x USB 2.0
Serial Port	N/A
IEEE 1394	N/A
LAN	1 x Gigabit
Parallel	N/A
GPIO	N/A
Smart Battery	
External Smart Battery	N/A
OS Support	
OS Support	N/A
Power/Thermal Specs	
Power Requirement (Max)	Powered By 802.3bt Type 3/4 PoE
Power Consumption (Max)	30 W
Recommended Power Supply	43 W
Heat Dissipation	103 BTU/hr
Physical Information	
Mounting	Pedestal, VESA, Wall and Ceiling mount, Benchtop
Net Weight	34 Lbs / 15.42 Kg
Dimension (W x H x D)	15.88 x 14.07 x 4.36 inch 403.4 x 357.4 x 110.7 mm
Recommended Cutout Dimension (WxH)	N/A
IP/NEMA Rating	Meets NEMA 4X
Certification	N/A
Environmental	
Operating Temperature	0~50°C (32~122°F)
Storage Temperature	-20~60°C (-4~140°F)
Relative Humidity	0~95%

Dimension Drawing

ARP-5517AX-E01-A06
Size Unit: mm

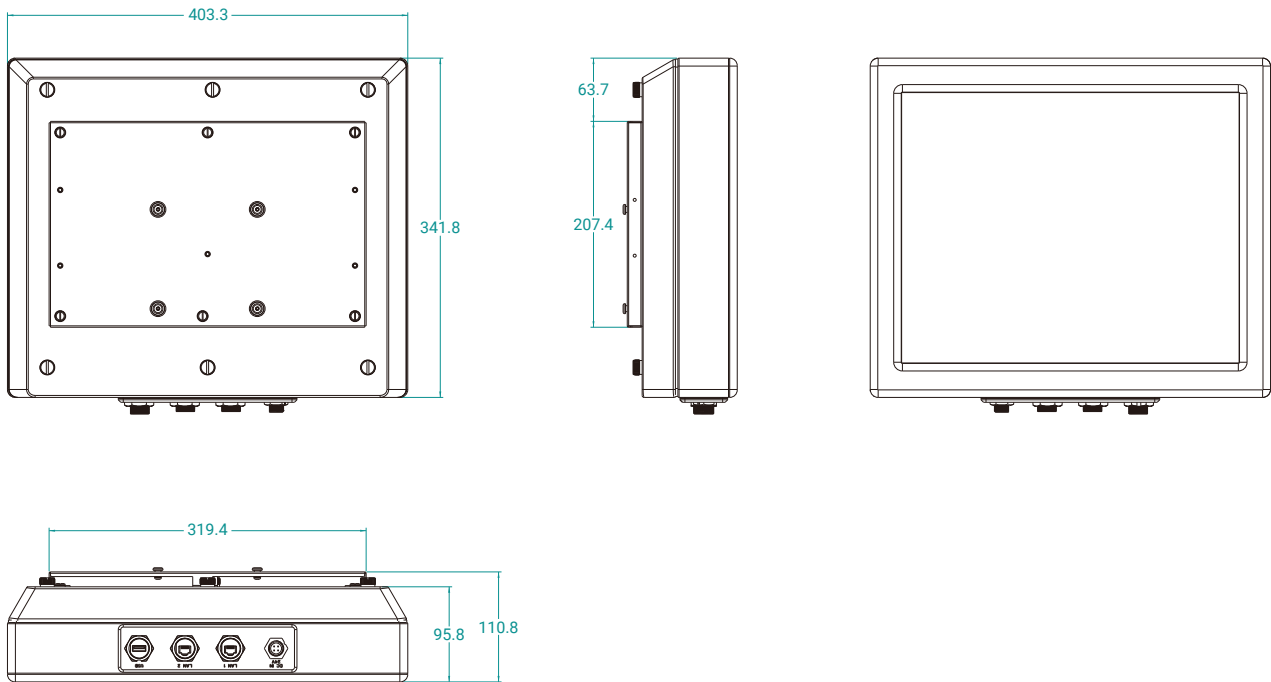

Ordering Information

Item	ARP-5517AX-E01-A06
LCD Display	17.0" LCD / 1280 x 1024
Touch Screen	5-Wire
Enclosure	Stainless Steel
CPU	Intel Celeron J1900 @ 1.99GHz / Atom E3845 @ 1.91GHz CPU
Memory	4GB DDR3
Storage	N/A
Remote Boot	ThinManager Ready
Power Supply	Powered by PoE 802.3bt (PoE Injector can be ordered seperately)